



TEREX®

Company Profile



WWW.TEREX.COM

Welcome

Contents

3. Who We Are: Our Company	4. Our Purpose	5. Zero Harm Safety	6. Terex Way Values
7. Inclusion	8-9. Sustainability	10. Executive Leadership Team	11. Our Team
12. Where We Operate	13. Our Business Strategy	14. Our Segments	15-35. Materials Processing Segment
36-51. Genie	52-60. Terex Utilities	61. Terex Financial Services	62. Additional Information

Who We Are

Our Company

Terex is a diversified global manufacturer of materials processing machinery and aerial work platforms.

We design, build and support products used in construction, maintenance, manufacturing, recycling, energy, minerals, and materials management applications.

Our products are manufactured in North and South America, Europe, Australia, and Asia and sold worldwide.

We operate in two segments: Materials Processing (MP) and Aerial Work Platforms (AWP).



Our Purpose

To help improve the lives of people around the world

Our Mission

To provide solutions to our machinery and industrial product customers that yield superior productivity and return on investment

Our Vision

- ✓ To be the **safest** and **best place to work** in the industry
- ✓ To be the **most customer-responsive** company in the industry, as determined by our customers
- ✓ To be the **most profitable** company in the industry, as measured by our return on invested capital (ROIC)



Our Values

Zero Harm Safety

Zero Harm Safety

is an absolute way of life at Terex, whether you work for us, supply us, use our equipment, or receive our services



Our Values

Terex Way Values

Terex Way Values

Integrity, Respect, Improvement, Servant Leadership, Courage and Citizenship help guide us in everything we do



Our Values

Inclusion

Inclusion Starts with 'I'

These are actions each of us must take to ensure that ALL our team members feel safe, supported and valued

INCLUSION STARTS WITH "I"



Sustainability – Our Commitment



Environmental Stewardship

- Innovating Environmentally Friendly Products
- Operating in an Environmentally Friendly Manner
- Offering 69%+ of all Terex Models as Electric or Hybrid Electric
- Targeting 15% GHG Emission Reduction by 2024*



Commitment to Social Responsibility

- Engaging and Developing Team Members
- Supporting Communities
- Ensuring Diversity, Equity and Inclusion
- Focusing on Zero Harm



Strong Governance

- Engaged, Diverse, Independent Board of Directors
- Responsible, Ethical Leadership

Sustainability – Our Impact



Helping our customers and communities achieve sustainability goals by enabling efficient waste recycling



Producing equipment across all our businesses that are available as electric and/or hybrid including 70% of Genie and MP products



Developing an all-electric powered mechanical separation process tailored to customer requirements

Developing the industry's first all-electric utility bucket truck



Recovering higher value metals, aggregate, plastic, cardboard from Commercial & Industrial, Construction & Demolition waste



Providing high quality outputs with low labor intensity and clean environmental footprint

Reducing our own energy use and GHG emissions worldwide



TRS Plant in the U.K.

Who We Are

Terex Executive Leadership Team



Simon A. Meester
President &
Chief Executive Officer



Julie A. Beck
SVP &
Chief Financial Officer



Joshua Gross
President,
Genie



Kieran Hegarty
President,
Terex Materials Processing



Amy J. George
SVP & Chief Human
Resources Officer



Stacey Babson Kaplan
SVP, Chief Sustainability &
Compliance Officer



Scott J. Posner
SVP, General Counsel
& Secretary



R. Mark Cox
SVP, Corporate
Development

Our Team

Team members are our greatest asset and best investment



A Strong and Supportive Team
Committed to Safe Work Practices



Committed to Diversity, Equity and
Inclusion



Helping Team Members Reach Their
Full Potential

Where We Operate

Geographically diverse with operations all over the world

Terex Sales by Geography

- North America
- Western Europe
- Asia / Pacific
- Rest of World

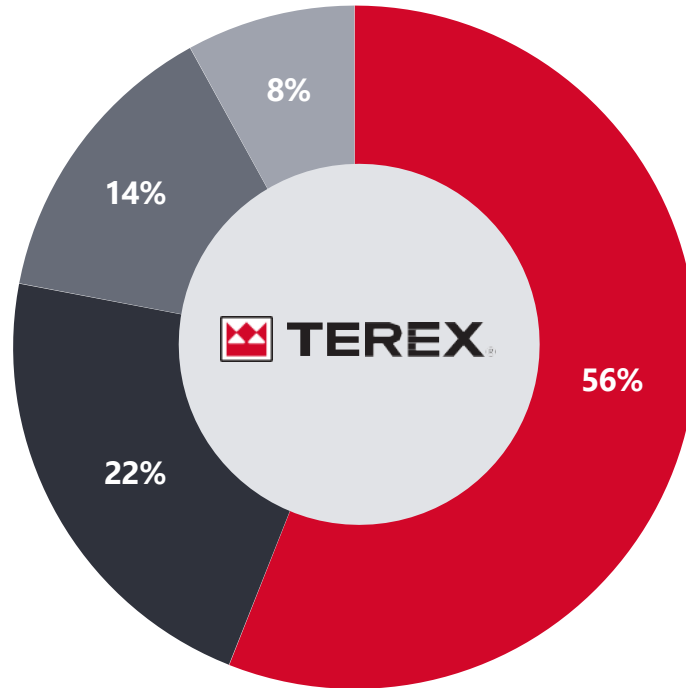

*FY 2022



Our Business Strategy

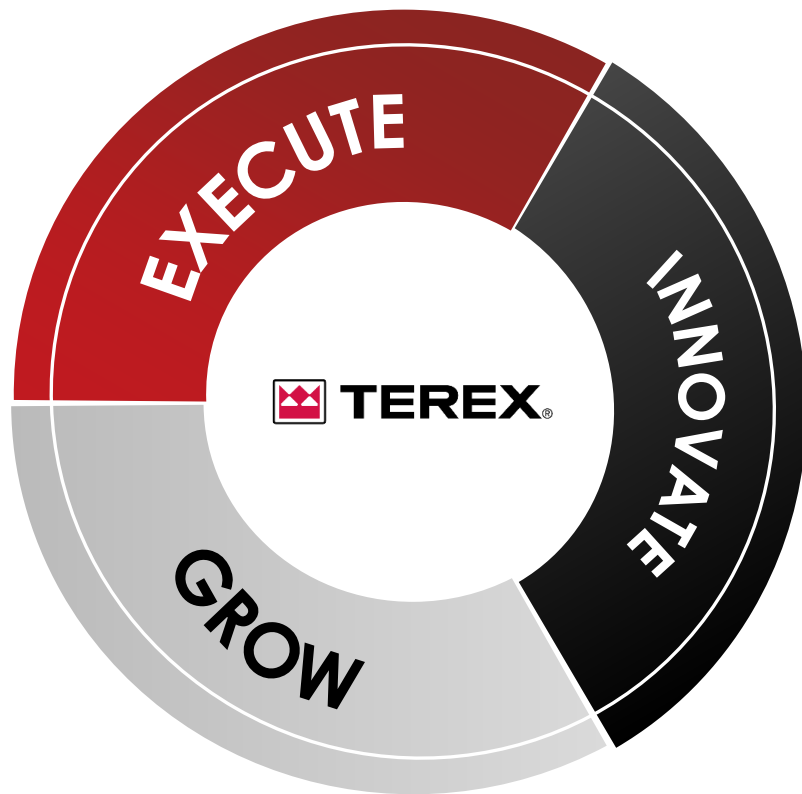

Execute

- ✓ Safety
- ✓ Commercial & Operational Excellence
- ✓ Team: DE&I, Talent Development, Retention
- ✓ Scalable Company Operating System

Innovate

- ✓ Product Development
- ✓ Lifecycle Solutions Development
- ✓ Electrification
- ✓ Digitization

Grow

- ✓ Superior Customer Lifecycle Experience
- ✓ Expand Addressable Markets
- ✓ Portfolio Development

Our Segments

Materials Processing Aerial Work Platforms

Materials Processing (MP)

Terex MP is a substantial portfolio of businesses that serves five key verticals: Aggregates, Environmental, Concrete, Handling and Lifting. Sold through a specialized distribution network or directly to end customers and rental companies.



Aerial Work Platforms (AWP)

Genie and Terex Utility products are used to lift personnel and material safely to height. These are leading global brands known for quality, purposeful innovation and customer support.





Materials Processing Segment

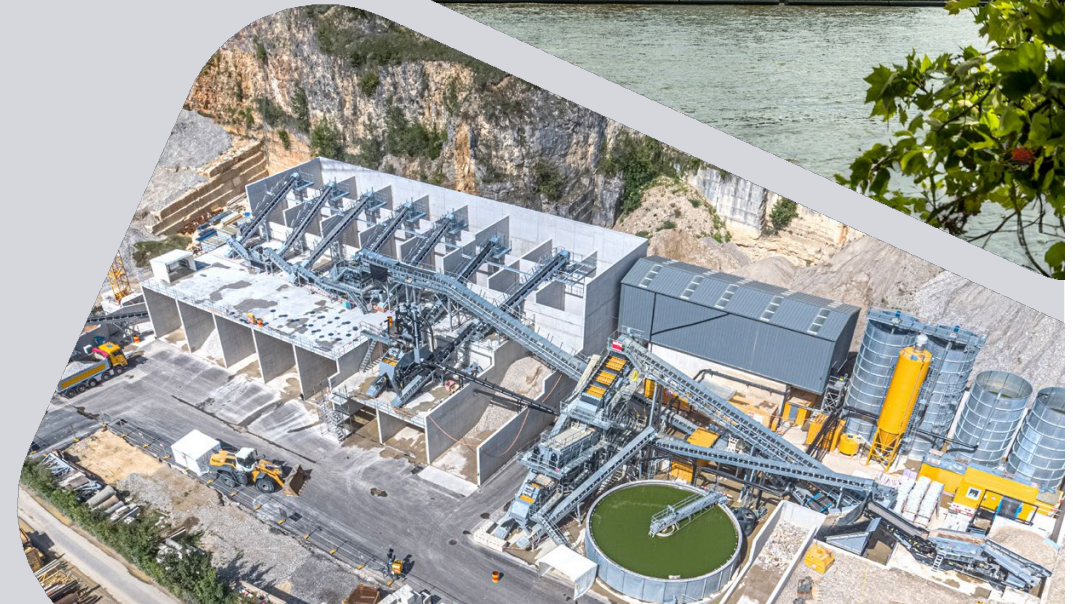

Specialized Diversified Business Portfolio

Aggregates



Mobile, modular, portable, and static **solutions** to support crushing, screening, washing, recycling and conveying applications for the world's minerals, aggregates and construction industries.

Environmental



Mobile, stationary and modular recycling **solutions** for grinding, shredding, screening, separating and sorting to recycle and repurpose a wide variety of waste material and contribute to the circular economy.

Concrete



Concrete mixing and paving **solutions** to support concrete delivery and heavy highway construction.

Handling



Handling and conveying **solutions** to move material efficiently and cost-effectively.

Lifting



Tower, rough terrain and pick and carry crane **solutions** to support multiple applications where speciality lifting is required.

Addressable Markets – Materials Processing



Aggregates

\$7B

Equipment reduces GHG emissions by processing on site



Environmental

\$3B

Supports recovery of useful material from waste streams



Concrete

\$1.5B

Increases labor productivity and reduces waste



Material Handling

\$1.1B

Handles scrap steel and mixed waste for recycling



Lifting

\$3.4B

Tools that build and enable global infrastructure

SERVING BROAD

~\$17B

ADDRESSABLE MARKET

Diverse applications

Consistent operating model

Strong channels

Favorable macro tailwinds

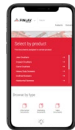

\$1.2B

Parts & Service Opportunity



Aggregates

- ✓ **#1** globally in mobile crushing & screening
- ✓ **#1** globally in heavy-duty trommels
- ✓ **Top 3** in other categories
- ✓ Recent addition of **Marco conveyors**



AGGREGATE BRANDS





Aggregates

Applications

- **Comprehensive** range of applications
- Mobile, modular, portable and static solutions
- Decades of engineering, design and manufacturing **excellence**
- Supporting distribution network and end customers **daily** through applications expertise, parts and service
- Marco provides bulk material handling solutions for the concrete, aggregate and barge loadout industries with a standard and built for purpose range of equipment



APPLICATIONS

- ✓ Mining & Quarrying
- ✓ Road & Rail Construction
- ✓ Land Clearing/Demolition
- ✓ C&D Recycling
- ✓ Washing & Water Management
- ✓ Fracking/Frac Sand
- ✓ Green Waste/Compost
- ✓ Abrasive Rock & Mineral Processing



Aggregates

Product Lines





Aggregates

Product Lines



Modular



Classifying



Scrubbing



Screening



Feeding



Stacking



Water Management



Greenline



Tracked Trommels



Static Trommels



Recycling Trommels



Conveyors



Tracked Stackers



Wheeled Stackers



Tracked Feeders

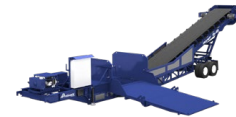

Bulk Reception Feeders



Telescopic Conveyors and Ship Loaders



Dockside Reception Hoppers



Concrete Industry Feeders



Static Conveyors



Portable Conveyors



Custom Projects





Aggregates

Product Lines

CANICA[®]
A TEREX BRAND



Portable VSI Crushers



Static VSI Crushers



Modular VSI Crusher

Cedarapids[®]
A TEREX BRAND 1923-2023

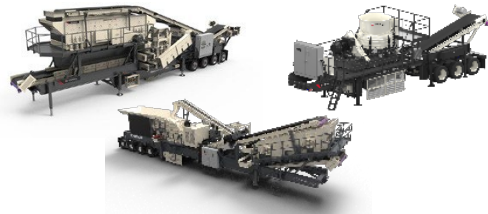

Portable
Jaw, Cone HIS, VSI, Screen,
Wash Plant & Rip Rap

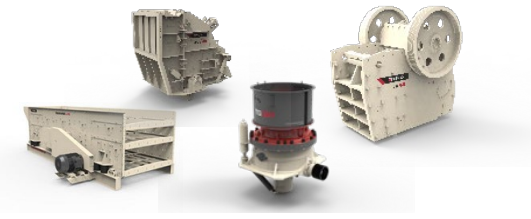

Static
Jaw, Cone Crusher, Crusher,
Screen, & Feeder



Modular
Jaw Crusher, Cone Crusher,
Screen & Surge Bin

1921 - 2021
SIMPLICITY[®]
A TEREX BRAND



Portable
Screens

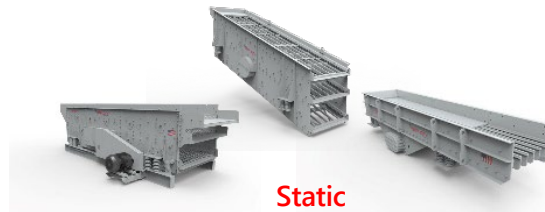

Static
Horizontal & Incline Screens
Vibrating Feeders



Modular
Screens



Environmental

- ✓ First environmental business established in **2015**
- ✓ Now **#3** globally in mobile wood & waste processing
- ✓ Recent entry into stationary systems
- ✓ New addition of Green-Tec – tree care and vegetation management solutions

Circular economy driving demand

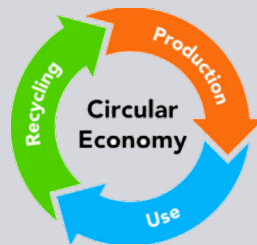

ENVIRONMENTAL BRANDS

TEREX®

ECOTEC



GREEN-TEC™
A TEREX BRAND

TEREX®

RECYCLING
SYSTEMS

ZENROBOTICS®
A TEREX BRAND





Environmental

Applications

- **Comprehensive** range of mobile grinding, shredding, screening, separating and processing equipment
- **Enormous** growth sector
- Product portfolio continuing to grow to offer "one stop shop" for recycling needs



APPLICATIONS

- ✓ MSW Processing
- ✓ Construction & Demolition Waste
- ✓ Commercial & Industrial Waste
- ✓ Green Waste/Compost
- ✓ Biomass
- ✓ Land Clearing
- ✓ Forestry Debris
- ✓ Saw Mills
- ✓ Pulp Mills
- ✓ Biomass to Energy Plants
- ✓ Pellet Mills
- ✓ Wood Pellet Production
- ✓ Coal
- ✓ Incineration Plants
- ✓ Tree Care
- ✓ Vegetation Management



Environmental

Product Lines



Shredders



Screens



Material Handlers



Conveyors



Separators



A TEREX BRAND



Horizontal Grinders



Wood Chippers



Flail Debarkers



Screens



Conveyors



Attachments



A TEREX BRAND



Tree Care Chippers



Biomass Chippers



Tree Handlers



Trommels



Crawler Booms



Shredders



Environmental

Product Lines



Feeders



Conveyors



Trommels



Screens

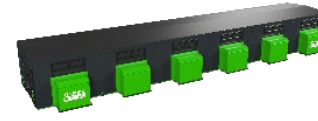

Picking Stations



Shredders



Separators

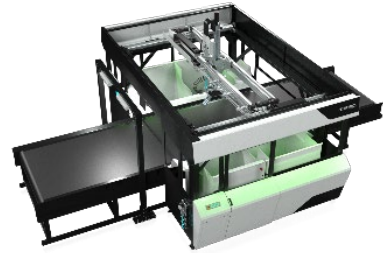

Heavy Picker



Fast Picker



Standalone System



Concrete



#1 or #2 in N.A. Concrete Categories Recent addition of ProAll

Well-positioned to support increased investments in infrastructure



CONCRETE BRANDS

ADVANCE
A TEREX BRAND

PROALL
A TEREX BRAND

BIO-WELL
A TEREX BRAND



Concrete

Applications

- **Comprehensive** range of concrete mixers and concrete paving machines
- Advance develops front and rear discharge concrete mixers
- Bid-Well manufactures **versatile** and **specialized** concrete paving machines for the heavy and highway construction market
- Addition of ProAll to grow in an adjacent concrete category (volumetric mixers)



APPLICATIONS

- ✓ Road & Rail Construction
- ✓ Airport Runway Construction
- ✓ Tunnels
- ✓ Flatwork
- ✓ Bridge Construction
- ✓ Dams
- ✓ Slopes and Canals
- ✓ Bulk Material Leveling
- ✓ Overlays



Concrete

Product Lines

ADVANCE
A TEREX BRAND



Front Discharge



Mini-Mix

BIGWELL
A TEREX BRAND



Roller Paver



Bridge & Flatwork



Texture & Curing



Workbridge



Canal Paver

PROALL
A TEREX BRAND



G95 Mixer



P85 Mixer



Handling

- ✓ #3 in Purpose-Built Material Handlers
- ✓ ProStack telescoping conveyors and hoppers

HANDLING BRANDS





Handling

Applications

- Comprehensive range of material handlers and conveyors
- Fuchs manufactures purpose-built material handlers for the waste, scrap, port and timber industries, plus tailor-made solutions to meet special requirements
- ProStack develops conveyors to address the needs of the bulk material handling and product stockpiling markets



APPLICATIONS

- ✓ Mining & Quarrying
- ✓ Land Clearing
- ✓ C&D Recycling
- ✓ Forestry/Forestry Waste
- ✓ Green Waste/Compost
- ✓ Bulk Material Handling
- ✓ Ports & Terminals



Handling

Product Lines



Waste Handling



Scrap Handling



Port Handling



Timber Handling



Customized Machines



Tracked Stackers



Wheeled Stackers



Tracked Feeders

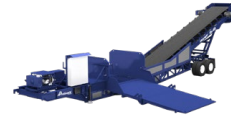

Bulk Reception Feeders



Telescopic Conveyors and Ship Loaders



Dockside Reception Hoppers



Lifting

- ✓ #1 in Australia Pick & Carry Cranes
- ✓ Region specific leadership in rough terrain and tower and self-erecting cranes



LIFTING BRANDS





Lifting | Applications

- Comprehensive range of tower cranes, rough terrain cranes and mobile pick and carry cranes
- Tower cranes include self-erecting, hammerhead, flat top and luffing jib varieties, each with a wide range of sizes and capacities
- Rough terrain cranes provide excellent ground clearance and up to four steering modes, ensuring they can handle even the most rugged terrain
- Franna pick and carry cranes provide strength and easy operation to pick up heavy loads and steering flexibility to move in tight spaces

APPLICATIONS

- ✓ Oil & Gas
- ✓ Construction
- ✓ Mining
- ✓ Shipping & Logistics
- ✓ Material Handling
- ✓ Power Plants
- ✓ Machine Installation & Maintenance
- ✓ Infrastructure





Lifting

Product Lines



AT 15-3



AT 22



MAC 25-4



AT 40



Self Erecting



Hammerhead



Flat Top



Luffing Jib



TRT 35



TRT 40US



RT 1045



RT 1045/L



TRT 65



TRT 70US



RT 1070



RT 1080



TRT 80



TRT 80US



TRT 90



TRT 100US

Genie® Nearly 60 Years of Quality



Genie®

QUALITY ^{BY} DESIGN.

Addressable Markets – Genie

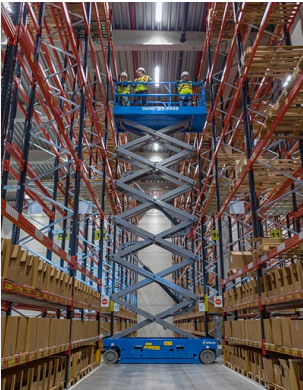

Construction

\$6B

- Commercial
- Institution
- Residential



Government & Infrastructure

\$2B

- Utilities
- Data Centers
- Military



Industrial & Manufacturing

\$3B

- Maintenance
- Process Control
- Operations



Agriculture

\$2B

- Material Handling
- Surface Preparation
- Processing



Emerging Markets

\$1B

- Entertainment
- Events
- Distribution

Construction Applications

Non-Construction Applications

SERVING BROAD

\$15B

ADDRESSABLE MARKETS

Adding new markets

Favorable megatrends

Diverse customers & applications

\$1B

Parts & Service Opportunity

Portfolio of Products

Delivering quality through application expertise and manufacturing excellence

5 5 4 1 5

MACHINES A YEAR

2 7 7

UNITS PER DAY

7 3

MODELS

24/7

GLOBAL PRODUCTION

Material Lifts

Compact, lightweight and easy to transport



Aerial Work Platforms

Convenient and cost effective



Scissor Lifts

Elevated efficiency that's easy to maneuver



Telescopic Boom Lifts

Greater horizontal outreach with precise positioning



Articulating Boom Lifts

Up, out and over reach for hard-to-access workspaces



Telehandlers

Rugged design and performance for outdoor material handling



Established Player, Global Leader



57 Years

Keeping People
Safe at Height



#1 or #2 Position

in Most Markets



100+ Countries

Global & Competitive
Footprint

Application Highlights – Boom Lifts



Competitive Strengths



Material Lifts



Aerial Work Platforms

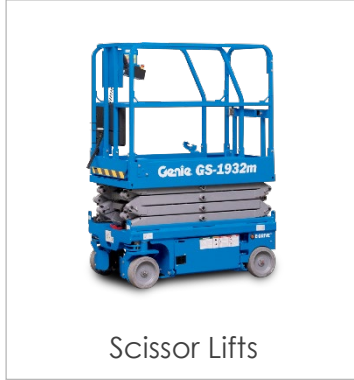

Scissor Lifts



Telescopic Boom Lifts

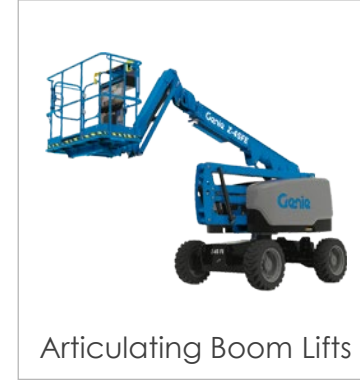

Articulating Boom Lifts



Telehandlers

Our Brand

- Globally recognized brand
- Extensive and deep experience in developing, testing, validating and marketing of products and solutions that keep people safe and deliver attractive return on assets

Our Product

- Wide, deep and broad product portfolio
- Operating at the cutting edge of innovation (i.e., electrification, TCO focused)

Our Support

- Industry leading Parts & Services footprint
- 55,000 connected assets providing actionable feedback

Application Highlights – Scissor Lifts



Application Highlights – Telehandlers



Application Highlights – Material Lifts

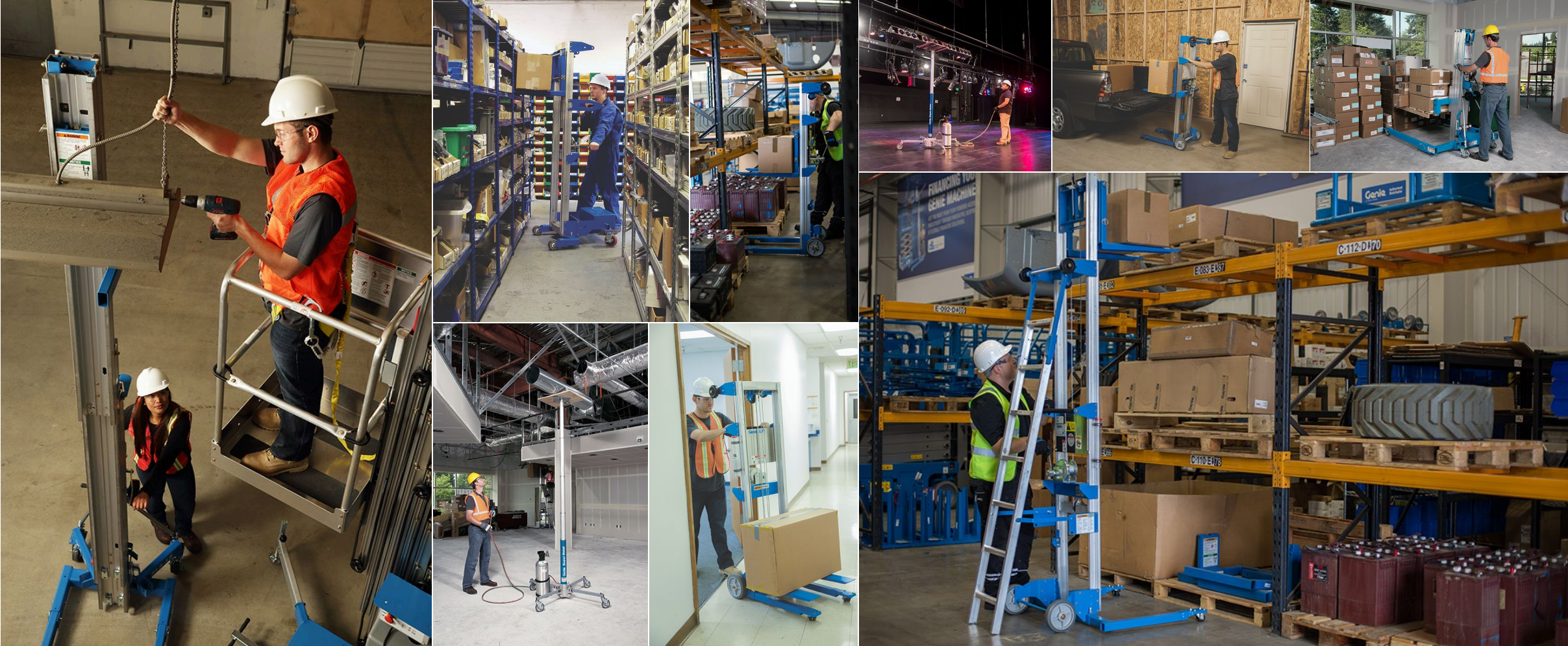

Application Highlights – Aerial Work Platforms



Scissor Lifts

Elevated efficiency that's easy to maneuver

Applications:

- Slab/indoor – HVAC, indoor maintenance and construction, painting, drywall
- Rough terrain – exterior finishing, rugged worksites
- E-Drive Scissor series – for both in- and outdoor jobsites

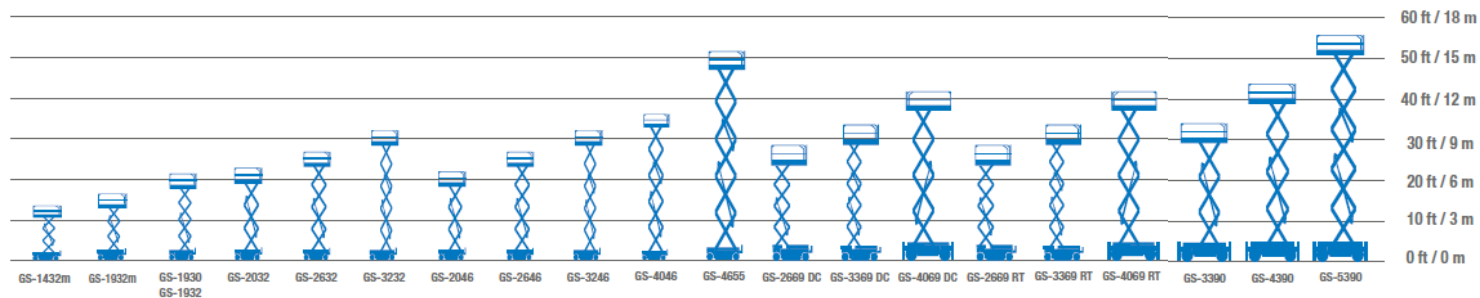

Designation Rules

GS™ = Genie® Scissor Lift

Example: GS™-1932 (19 ft / 5.79 m) floor height; (32 in / 81 cm) machine width

Ex: GS™-2669 RT (26 ft / 7.9 m) floor height; (69 in / 1.75 m) machine width; (RT = Rough Terrain) all-terrain model

- The first two letters stand for the type of elevator, the first set of two digits for the floor height in feet (ft), and the second set of two digits for the width of the machine in inches (in).
- Also referred to as: scissor lift, vertical elevator, mobile aerial work platform, self-propelled aerial work platform and electric scissor lift

Articulating Boom Lifts

Up, out and over-reach for hard-to-access jobs

Applications:

- ➔ Electric – industrial or warehouse use
- ➔ Rough Terrain Diesel – rugged construction sites
- ➔ Rough Terrain Hybrid – indoor & outdoor versatility

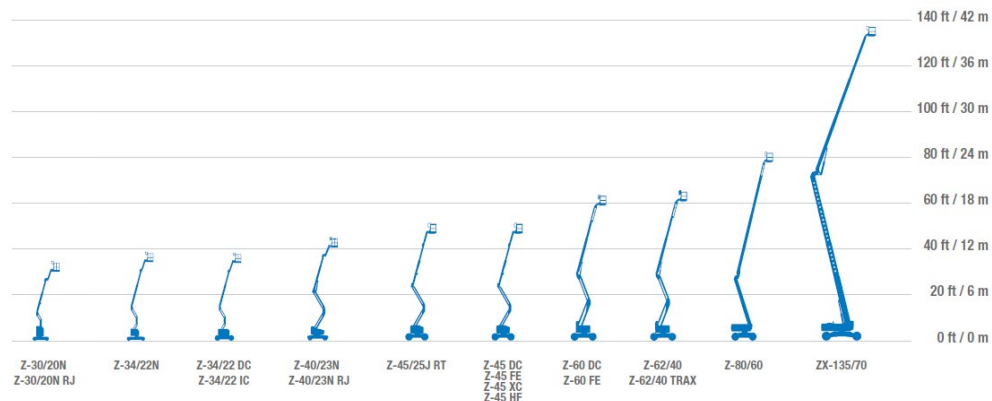

Designation Rules

Z[®] = Genie[®] Articulated Boom lift

Example: Z[®]-45/25 DC (45 ft /13.87 m) floor height; (25 ft /7.62 m) horizontal reach; DC power)

Ex: Z[®]-45 XC™ = Xtra Capacity™

Ex: Z[®]-60 FE = Fuel Electric (Hybrid)

Ex: Z[®]-62/40 TraX = 4 independents tracks systems

- The first letter is the type of aerial platform, the first number is the floor height in feet (ft), and the second number is the reach in feet (ft).
- Also referred to as: Z-arms, Z's, articulated booms, tilt booms, cherry picker, aerial work platforms

Telescopic Boom Lifts

Greater horizontal outreach with precise positioning

Applications:

- ➔ Outdoor maintenance and construction
- ➔ Road and bridge work
- ➔ Steel erection and exterior finishing

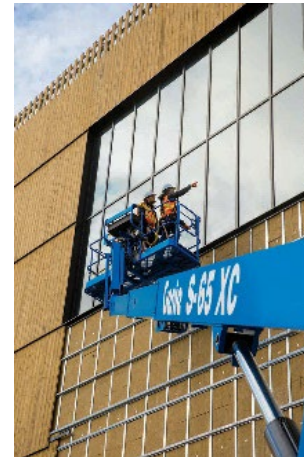
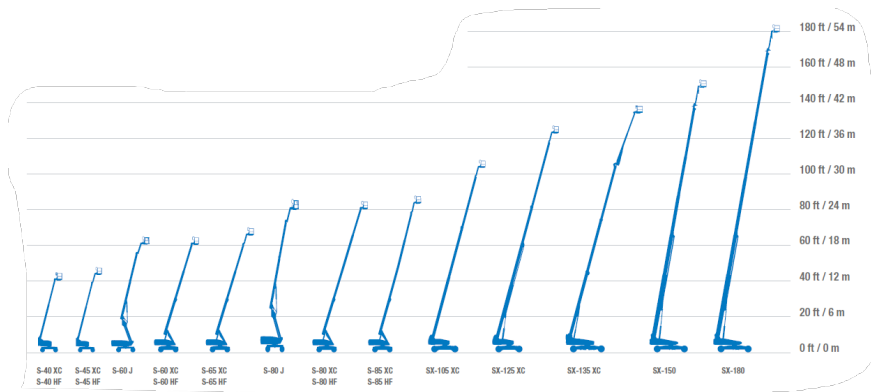

Designation Rules

S[®] = Genie[®] Telescopic Boom lift

Example: S[®]-65 XC (65 ft/ 19.80 m) floor height; represents a 60 ft/ 18.30 m boom extended by a 5 ft / 1.52 m jib. XC[™] = Xtra Capacity[™]

Ex: S[®]-60 J (standard 5 ft Jib included)

Ex: S[®]-65 TraX = 4 independents tracks systems

Ex: S[®]-60 FE = Fuel Electric (Hybrid)

Ex: SX[™]-180 = Super Boom family with Chassis X-tend technology

- The first letter stand for the type of platform, the first number for the floor height in feet (ft), and the unit 5 added to each full ten corresponds to the 5 ft (1.52 m) jib.
- Also known as straight booms and aerial work platforms

Telehandlers (ANSI)

Outstanding design and performance

Applications:

- ➔ Outdoor maintenance and construction
- ➔ Road and bridge work
- ➔ Steel erection and exterior finishing



Range of motion GTH-1056
with stabilizers up

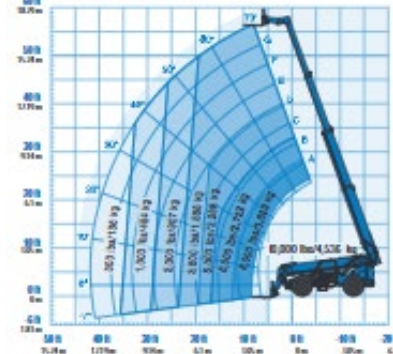

Range of motion GTH-1056
with stabilizers down

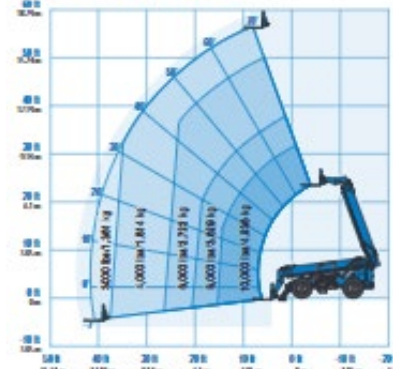

Designation Rules

GTH™ = Genie® Rough Terrain Telehandlers

Example: GTH®-5519 (19 ft/ 5.79 m) lifting max. height; (5,511 lb/ 2,500 kg) lifting capacity max.

Ex: GTH™-844

- The three letters stand for Genie Tele Handlers. The first number is the lifting max capacity followed by the lifting height max.
- Also known as Handlers, Materials handling

Material Lifts

Compact, lightweight and easy to transport

Applications:

- ➔ Plumbing and HVAC installation
- ➔ Manufacturing facilities and warehouses
- ➔ Lighting and sound equipment (SuperTower™)

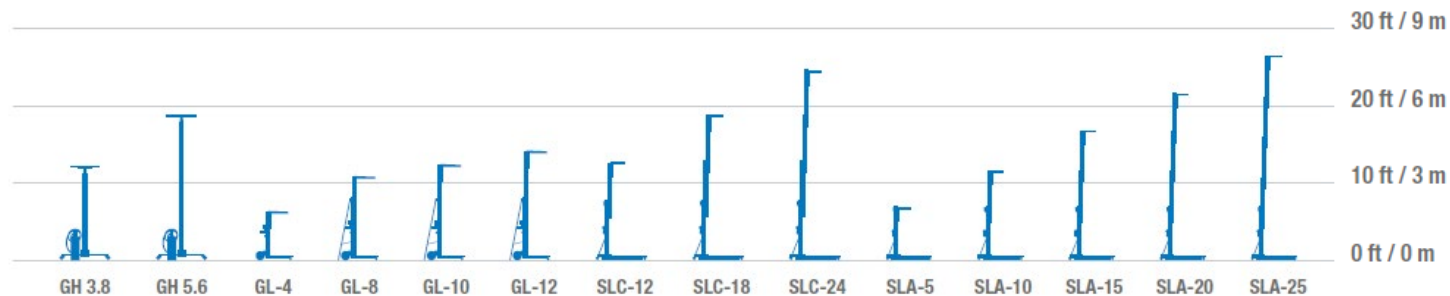

- Manufactured in Redmond, WA
- Applications: piping systems, manufacturing, warehouse, HVAC
- Ability to fit through standard doors
- Compact solution that can be loaded onto a truck by one person
- Lifts loads from 300 lb (91 kg) to 1,000 lb (454 kg) to a height of 20 ft (7.9 m)

Aerial Work Platforms

Convenient and cost effective

Applications:

- ➔ Construction, industrial facilities and warehouses
- ➔ Overhead maintenance, cleaning, hanging signage, etc.

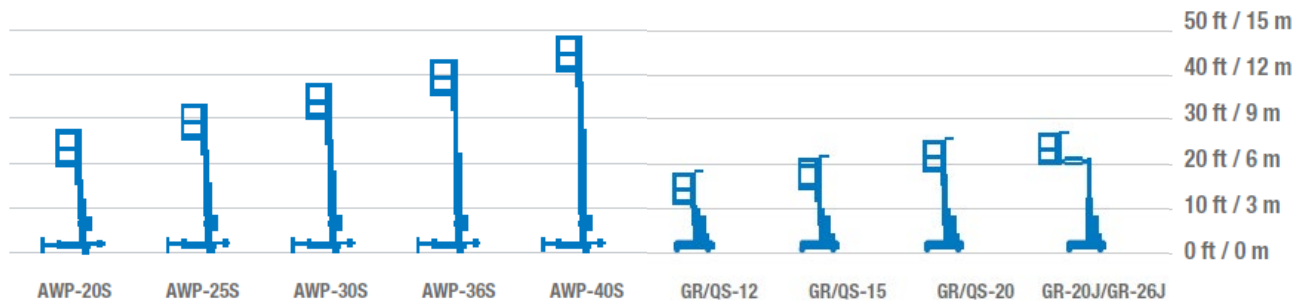
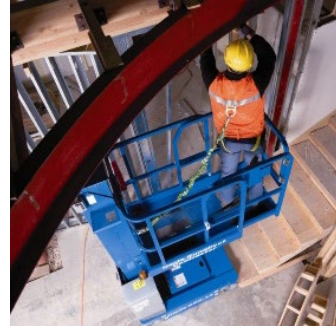

- Manufactured in Redmond, WA
- Applications: construction, industrial, maintenance and storage
- Ability to fit through standard or industrial doors
- AWP® models feature industry-leading X-stabilizers
- Lift loads up to 750 lb (340 kg) up to 40 ft (12.2 m) high

Pioneers of Innovation for More Than 75 Years



Terex Utilities

Portfolio of Products



Digger
Derricks



Articulated
Aerials



Telescopic
Aerials



Transmission
Aerials



Tree Care
Aerials



Green
Solutions



Substation
Safety



Installation



Upgrades



Repairs

Terex Utilities

Addressable Markets

\$2B

Addressable Market In US*
Growing >6% Annually

#2

In US Insulated
Equipment

#1

With
Contractors &
Tree Care

Terex Utilities Advantages

- Technology leadership in insulated offerings
- Newly consolidated factory footprint
- Leader in equipment electrification
- Positioning for growth outside the US

~ 25%

Of Sales From Parts & Services

21

US Service Locations

> 60

Field Service Technicians

Terex Utilities

Long Track Record of Purposeful Innovation



- **Industry's first** all-electric Utility Truck
- Leverages **Viatic Smart PTO** and Navistar's electric chassis
- **Extending to other models**



- Genie/Utilities collaboration
- Improves **safety in electrical substations**
- Exploring **potential in other applications**



- **Digital tools** enhance customer experience
- eCom integration **enables parts fulfillment**

Viatec SmartPTO

- Modular, electric powered PTO designed by leading experts in the field
- Eliminates the need for idling when operating boom, winch, and air conditioning on aerials
- Capable of providing a full day of service on a single charge
- Capable of powering outrigger and boom functions on diggers (reduced dig and winch functions)
- Allows engine off air conditioning through the chassis vents



Terex Utilities

Z-45 and Z-60 Substation Utility Booms

- Purpose built mobile elevated work platform (MEWP)
- Designed for substation work and other applications where an isolated device is needed but use of a bucket truck is prohibitive.
- Upfitted with fiberglass jib sections, fiberglass platform and fiber optic platform controls.

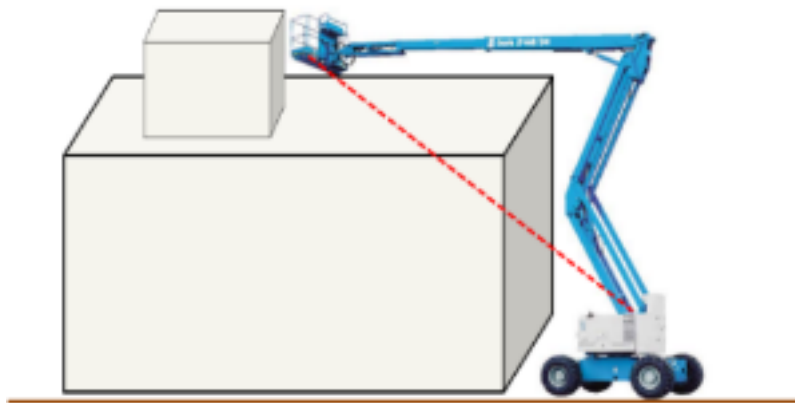

Up & Over Capability



Terex Utilities

Hi-Ranger TL48 Telescopic Aerial

- Superior jib capacities to meet trouble truck application needs
 - Working Height: 53 ft on a Super-Duty chassis, while maintaining required payload and jib capacity
 - Side reach: 31.77 ft
 - Bucket Capacity: 500 lbs plus Max. Material Handling Capacity of 1,000 lbs
 - Close to horizontal position: 800 lbs jib capacity; 200 lbs fully extended (where similar units have no material handling capacity)



- Optimized payload with new Super-Duty chassis such as the 22K+ GVW F600, International CV & Chevrolet
- Ground access for ease of handing off tools, platform debris clean out & personnel rescue

Terex Utilities

General 65 Max

- Strongest digger in the transmission market
- Greater capacities through all boom angles – especially the work zone



Specification	New Gen 65 MAX with X-Boost	New Gen 65 MAX	Legacy Gen 65
Sheave Height	65.1 ft.	65.1 ft.	65.5 ft.
Capacity @ 10 ft. Radius (fully retracted)	24,920 lbs.	22,620 lbs.	19,770 lbs.
Capacity at 0 degrees (fully extended)	1,870 lbs	1,870 lbs	1,020 lbs.
Digging Reach	36.4 ft.	36.4 ft.	36.4 ft.

Terex Utilities

Positive Attachment Lanyard Device

- **PAL™ in the Bucket**

- Aids in supporting safe work practices by alerting the operator that lanyard is not attached
- Optional data recording for training purposes available.
- Available now on trouble trucks & tree trimmers & expanding to other aerial products



Terex Financial Services



Assisting in the **acquisition** and **funding** of equipment

- ✓ Leasing Solutions
- ✓ Dealer Floorplan Solutions
- ✓ Fair Market Value Lease Solutions
- ✓ Structured Loans
- ✓ Loans/Hire Purchase
- ✓ Facilities
- ✓ Used Equipment
- ✓ Financing Asset Management
- ✓ Stock Inventory and Retail Inventory Offerings

Additional Information



Additional information can be found at www.terex.com including:

- ▶ Investor information and resources
- ▶ Company news
- ▶ Product guide
- ▶ Career opportunities